

# THICK FILM (RESISTANT TO SURGE)



## SG73S、SG73P

耐浪涌片式电阻器 (SG73S)  
耐脉冲片式电阻器 (SG73P)

Endured Surge Voltage Flat Chip Resistors  
Endured Pulse Power Flat Chip Resistors

矩形片式电阻器  
Flat Chip Resistors

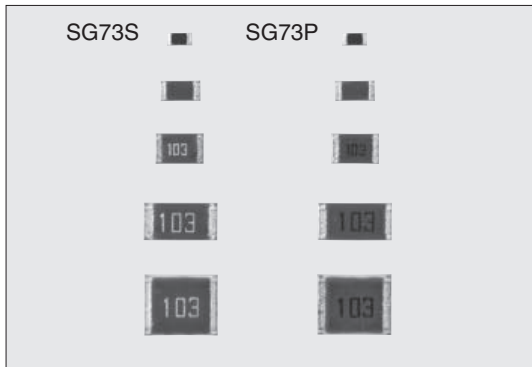

外观颜色: 黑色 (SG73S、SG73P 1E)  
绿色 (SG73S、SG73P 1J、2A、2B、2E)  
Coating color: Black (SG73S、SG73P 1E)  
Green (SG73S、SG73P 1J、2A、2B、2E)

### 特点 Features

- 与片状电阻器 (RK73) 相比, 浪涌耐压和脉冲耐压优异。
- 对应阻值允许偏差  $\pm 0.5\%$ 。
- 对应回流焊、波峰焊。
- 端子无铅品, 符合欧盟RoHS。电极、电阻膜层、玻璃中所含的铅玻璃不适用欧盟RoHS指令。
- AEC-Q200相关数据已取。
- Superior to RK73 series chip resistors in surge withstanding voltage and pulse withstanding voltage.
- Resistance tolerance is available from  $\pm 0.5\%$ .
- Suitable for both reflow and flow solderings.
- Products with lead free termination meet EU-RoHS requirements. EU-RoHS regulation is not intended for Pb-glass contained in electrode, resistor element and glass.
- AEC-Q200 qualified.

### 用途 Applications

- 发动机控制装置
- 感应闪电电路
- E.C.U.
- Circuits to catch inductive lighting surge.

### 参考标准 Reference Standards

IEC 60115-8  
JIS C 5201-8  
EIAJ RC-2134C

### 额定值 Ratings

型号 Type	额定功率 Power Rating	额定环境温度 Rated Ambient Temp.	额定端子部温度 Rated Terminal Part Temp.	电阻温度系数 T.C.R. ( $\times 10^{-6}/K$ )	电阻值范围 Resistance Range ( $\Omega$ )			最高使用电压 Max. Working Voltage	最高过载电压 Max. Overload Voltage	二次加工和包装数/卷 Packaging & Qty/Reel (pcs)		
					D: $\pm 0.5\%$ E24、E96	F: $\pm 1\%$ E24、E96	G: $\pm 2\%$ J: $\pm 5\%$ E24			TP	TD	TE
1E	0.125W	70°C	125°C	$\pm 200$	10~1M	1~1M	1~10M	50V	100V	10,000	-	-
	0.2W <sup>※2</sup>	-	105°C									
1J	0.2W	70°C	125°C	$\pm 100$ <sup>※1</sup>	10~1M	1~1M	1~10M	150V	200V	10,000	5,000	-
	0.25W <sup>※2</sup>	-	100°C									
2A	0.25W	70°C	125°C	$\pm 200$	10~1M	1~1M	1~10M	200V	400V	10,000	5,000	4,000
	0.5W <sup>※2</sup>	-	100°C									
2B	0.33W	70°C	125°C	$\pm 200$	10~1M	1~1M	1~10M	200V	400V	-	5,000	4,000
	0.5W <sup>※2</sup>	-	120°C									
2E	0.5W	70°C	125°C	$\pm 200$	10~1M	1~1M	1~10M	200V	400V	-	5,000	4,000

使用温度范围 Operating Temperature Range: -55°C~+155°C

额定电压是 $\sqrt{\text{额定功率} \times \text{公称电阻值}}$ 所算出的值或表中最高使用电压两者中小的值为额定电压。

Rated voltage =  $\sqrt{\text{Power Rating} \times \text{Resistance value}}$  or Max. working voltage, whichever is lower.

※1 冷T.C.R.为 $\pm 150 \times 10^{-6}/K$ 。 ※2 Cold T.C.R. is  $\pm 150 \times 10^{-6}/K$ 。

根据客户的使用状况, 如果不清楚是该使用额定环境温度还是额定端子部温度, 请以额定端子部温度为优先。

详情请参照14~17页的“端子部温度负荷特性曲线的说明”。

If any questions arise whether to use the “Rated Ambient Temperature” or the “Rated Terminal Part Temperature” in your usage conditions, please give priority to the “Rated Terminal Part Temperature”.

For more details, please refer to “Introduction of the derating curves based on the terminal part temperature” in page 14 to 17.

### 结构图 Construction

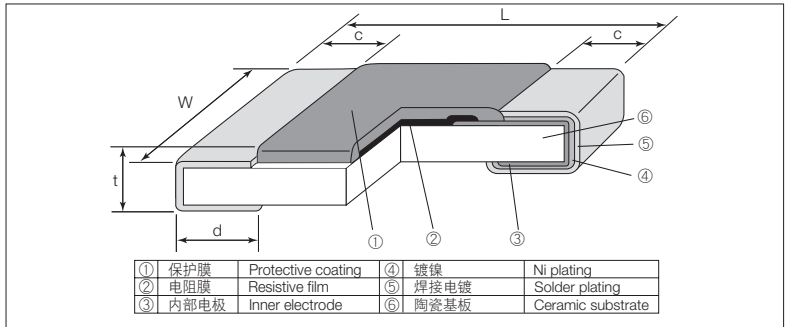

### 外形尺寸 Dimensions

型号 Type (Inch Size Code)	尺寸 Dimensions (mm)					Weight (g) (1000pcs)
	L	W	c	d	t	
SG73S1E、SG73P1E (0402)	1.0 <sup>±0.05</sup>	0.5 $\pm 0.05$	0.15 $\pm 0.1$	0.25 <sup>±0.02</sup>	0.35 $\pm 0.05$	0.68
SG73S1J、SG73P1J (0603)	1.6 $\pm 0.2$	0.8 $\pm 0.1$	0.3 $\pm 0.1$	0.3 $\pm 0.1$	0.45 $\pm 0.1$	2.14
SG73S2A、SG73P2A (0805)	2.0 $\pm 0.2$	1.25 $\pm 0.1$	0.3 <sup>±0.1</sup>	0.3 <sup>±0.1</sup>	0.5 $\pm 0.1$	4.54
SG73S2B、SG73P2B (1206)	3.2 $\pm 0.2$	1.6 $\pm 0.2$	0.4 <sup>±0.1</sup>	0.4 <sup>±0.1</sup>	0.6 $\pm 0.1$	9.14
SG73S2E、SG73P2E (1210)		2.6 $\pm 0.2$				15.5

### 品名构成 Type Designation

实例 Example

SG73S	2A	T	TD	103	J
品种 Product Code	额定功率 Power Rating	端子表面材质 Terminal Surface Material	二次加工 Taping	公称电阻值 Nominal Resistance	阻值允许偏差 Resistance Tolerance
SG73S SG73P	1E:0.2W 1J:0.25W 2A:0.5W 2B:0.5W 2E:0.5W	T: Sn	TP:2mm pitch punch paper TD:4mm pitch punch paper TE:4mm pitch plastic embossed BK:Bulk	D,F:4 digits G,J:3 digits	D: $\pm 0.5\%$ F: $\pm 1\%$ G: $\pm 2\%$ J: $\pm 5\%$

端子表面材质, 以无铅品为准。

欲知关于此产品含有的环境有害物质详情(除EU-RoHS以外), 请与我们联系。

编带细节请参考卷末附录C。

The terminal surface material lead free is standard.

Contact us when you have control request for environmental hazardous material other than the substance specified by EU-RoHS.

For further information on taping, please refer to APPENDIX C on the back pages.

## ■ 负荷减轻特性曲线 Derating Curve

环境温度 Ambient temperature

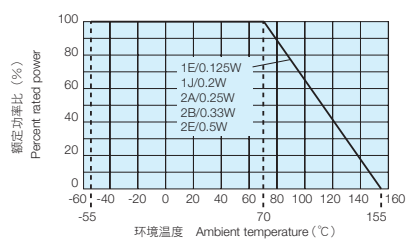

在环境温度70℃以上使用时，应按照上图负荷减轻特性曲线，减小额定功率。

For resistors operated at an ambient temperature of 70°C or above, a power rating shall be derated in accordance with the left derating curve.

端子部温度 Terminal part temperature

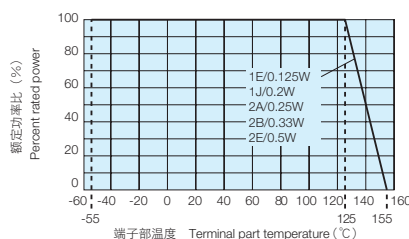

超过上述端子部温度使用时，请根据负荷减轻特性曲线减小额定功率后使用。

按照※2的额定功率使用时，请使用右侧端子部温度的负荷减轻特性曲线。

※有关使用方法，请参照卷首的“端子部温度负荷减轻特性曲线的说明”。

For resistors operated terminal part temperature of described for each size or above, a power rating shall be derated in accordance with derating curve.

If you want to use at the rated power of ※2, please use the derating curves based on the terminal part temperature of rightside.

※Please refer to "Introduction of the derating curves based on the terminal part temperature" on the beginning of our catalog before use.

端子部温度 Terminal part temperature

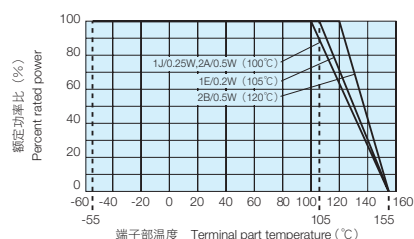

## ■ 单脉冲临界功率曲线 One-Pulse Limiting Electric Power

SG73P

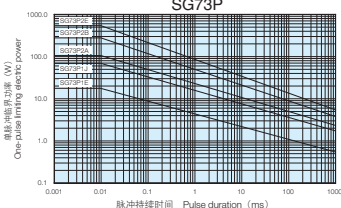

## ■ ESD临界电压 ESD Limiting Voltage

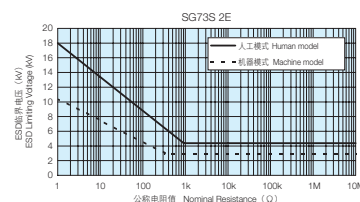
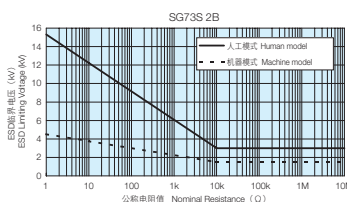
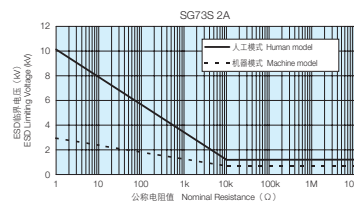
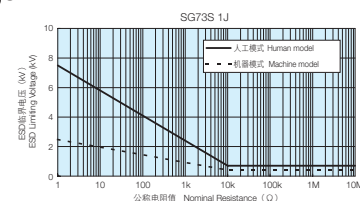
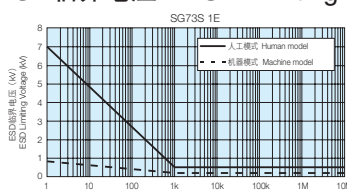

## ■ 性能 Performance

试验项目 Test Items	标准值 Performance Requirements $\Delta R \pm (\%+0.1Q)$		试验方法 Test Methods
	保证值 Limit	代表值 Typical	
电阻值 Resistance	在规定的允许偏差内 Within specified tolerance	—	25°C
电阻温度系数 T.C.R.	在规定值以内 Within specified T.C.R.	—	+25°C/-55°C and +25°C/+125°C
过载 (短时间) Overload (Short time)	2	0.5	额定电压×2.5倍施加5秒钟 (2A: 仅0.5W额定电压×2倍) Rated voltage×2.5 for 5s (2A : 0.5W, Rated voltage×2 for 5s)
耐焊接热 Resistance to soldering heat	1	0.75	260°C±5°C, 10s±1s
温度突变 Rapid change of temperature	0.5	0.3	-55°C (30min.) / +125°C (30min.) 100 cycles
耐湿负荷 Moisture resistance	3	0.75	40°C±2°C, 90%~95%RH, 1000h 1.5小时ON、0.5小时OFF的周期 1.5h ON/0.5h OFF cycle
在70°C时的耐久性 Endurance at 70°C	3	0.75	70°C±2°C, 1000h 1.5小时ON、0.5小时OFF的周期 1.5h ON/0.5h OFF cycle
高温放置 High temperature exposure	1	0.3	+155°C, 1000h

## ■ 使用注意事项 Precautions for Use

- 片状电阻器的基材是氧化铝。由于和安装基板的热膨胀系数不同，在反复提供热循环等热应力时，接合部的焊锡（焊接部）有时会发生裂纹。如果环境温度反复发生很大的变动，并且载荷反复进行ON/OFF，则需要注意龟裂的发生。因热应力而发生的龟裂，取决于所安装的焊盘的大小、焊锡量、安装基板的散热性等，因此在环境温度有很大的变化或载荷ON/OFF的条件下使用时，请充分注意以进行设计。
- The substrate of chip resistors is alumina. Cracks may occur at the connection of solder (solder fillet portion) due to the difference of the coefficient of thermal expansion from a mounting board when heat stress like heat cycle, etc. are repeatedly given to them. Care should be taken to the occurrence of the cracks when the change in ambient temperature or ON/OFF of load is repeated. The occurrence of the crack by heat stress may be influenced by the size of a pad, solder volume, heat radiation of mounting board etc., so please pay careful attention to designing when a big change in ambient temperature and conditions for use like ON/OFF of load can be assumed.

本样本手册中记载的产品规格如有变更，恕不一一奉告。订购以及使用之前，请仔细确认规格表的内容。

用于车载设备、医疗设备、航空设备以及其它涉及人身安全、或可能引起重大损失的设备上时，请务必事先与我司联系。这些产品在这类用途中出现故障或失灵可能导致人身事故或严重损坏。

Specifications given herein may be changed at any time without prior notice. Please confirm technical specifications before you order and/or use.

Contact our sales representatives before you use our products for applications including automobiles, medical equipment and aerospace equipment.

Malfunction or failure of the products in such applications may cause loss of human life or serious damage.